



USER MANUAL WASHING MACHINE



AL6205AIDV

Read this manual carefully and keep it for future reference.

CONTENTS

WARNING-----	3
PRECAUTIONS-----	5
COMPONENTS NAMES-----	7
INSTALLATION INSTRUCTIONS-----	8
DOOR LOCKING AND UNLOCKING METHODS-----	13
USAGE OF DETERGENT COMPARTMENT-----	14
SAFETY PRECAUTIONS BEFORE WASHING -----	15
FUNCTIONAL DESCRIPTION OF CONTROL PANEL -----	16
DESCRIPTION OF FUNCTIONAL PROGRAMS -----	17
DESCRIPTION OF WASHING PROGRAMS-----	18
MAINTENANCE AND SERVICING-----	19
TROUBLESHOOTING GUIDELINES-----	21
SPECIFICATIONS TABLE-----	22
NAME AND CONTENT OF HAZARDOUS SUBSTANCES USED IN THIS APPLIANCE---	23
AFTER-SALE SERVICE-----	24

WARNING

1. This appliance can be used by children aged from 8 years and above and persons with reduced physical sensory or mental capabilities or lack of experience and knowledge if they have been given supervision or instruction concerning use of the appliance in a safe way and understand the hazards involved. Children shall not play with the appliance. Cleaning and user maintenance shall not be made by children without supervision.

Children of less than 3 years should be kept away unless continuously supervised.

2. If the supply cord is damaged, it must be replaced by the manufacturer, its service agent or similarly qualified persons in order to avoid a hazard.

3. This appliance is not intended for use by persons (including children) with reduced physical, sensory or mental capabilities or lack of experience and knowledge, unless they have been given supervision or instruction concerning use of the appliance by a person responsible for their safety

Children should be supervised to ensure that they do not play with the appliance.

4. The openings must not be obstructed by a carpet.

5. This appliance is intended to be used in household and similar applications.

6. The lint trap has to be cleaned frequently!

7. Adequate ventilation has to be provided to avoid the back flow of gases into the room from appliances burning other fuels, including open fires.

8.

- Fabric softeners or similar products, should be used as specified by the fabric softener instructions.
- Items such as foam rubber (latex foam), shower caps, waterproof textiles rubber backed articles and clothes or pillows fitted with foam rubber pads should not be dried in the tumble dryer.
- Remove all objects from pockets such as lighters and matches.

9.

- WARNING: The appliance must not be supplied through an external switching device such as a timer, or connected to a circuit that is regularly switched on and off by a utility

10.

- For appliances with ventilation openings in the base. that a carpet must not obstruct the openings.
- That exhaust air must not be discharged into a flue which is used for exhausting

PRECAUTIONS

IF THE SUPPLY CORD IS DAMAGED, IT MUST BE REPLACED BY THE MANUFACTURE, ITS SERVICE AGENT OR SIMILARLY QUALIFIED PERSONS IN ORDER TO AVOID A HAZARD.

1. Electrical hazard:

- a. Please use a special power socket with good grounding.
- b. Please take the plug to insert and pull out the power cord. Do not use damaged power cord. When there is dirt on the plug-in of the power cord, wipe it with a dry cloth in time.
- c. Do not plug or pull the power plug in or out with wet hands.
- d. After use, please unplug the power plug for maintenance or cleaning.

2. Danger of fire or electric leakage:

- a. Do not let the washing machine close to the fire source, or put lighted cigarettes, candles and volatile materials on the washing machine.
- b. Please do not spill water directly on the washing machine control panel.
- c. Please don't put the washing machine in the place with serious water and moisture.
- d. Please fix the drain pipe before use, and make sure that the sewer is not

blocked.

3. Risk of burns due to high temperature:

- a. When washing at high temperature, the door glass will get hot. Please do not touch the door glass, especially children.
- b. When the door needs to be opened in high temperature washing, please wait until the temperature drops to the safe temperature and the door lock is automatically unlocked.

4. Risk of personal injury:

- a. Please handle the disassembled package in time. Do not let children touch or swallow it.
- b. Children are not allowed to operate or climb onto the washing machine to play.
- c. Please close the door when the washing machine is not in use to prevent children from entering the washing barrel.

5. Risk of damage to washing machine:

- a. Please don't put heavy objects on the washing machine.
- b. Two people are required to move or handle the washing machine.
- c. Please do not let non professionals repair or modify the machine.

6. Risk of damage to clothing:

- a. Please do not wash waterproof clothes, such as raincoats, down products, sleeping bags, etc.
- b. Only machine washable clothes can be washed. If in doubt, please follow the washing guide on the clothes.



7. Risk of explosion:

- a. Do not wash or dehydrate the clothes stained with kerosene, gasoline, diluent and other flammable materials.
- b. Do not operate the washing machine when the gas leaks.

8. When the power plug is pulled out, the door lock can be opened even if the water level in the barrel is high. Therefore, in any case, please confirm the water level in the barrel before opening the door. If the water level is high, please do not open the door to avoid unnecessary loss caused by water overflow.

COMPONENTS NAMES

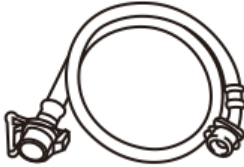
Description of accessories

Use manual	Inlet hose	Transport screw hole plug (4pcs)
		

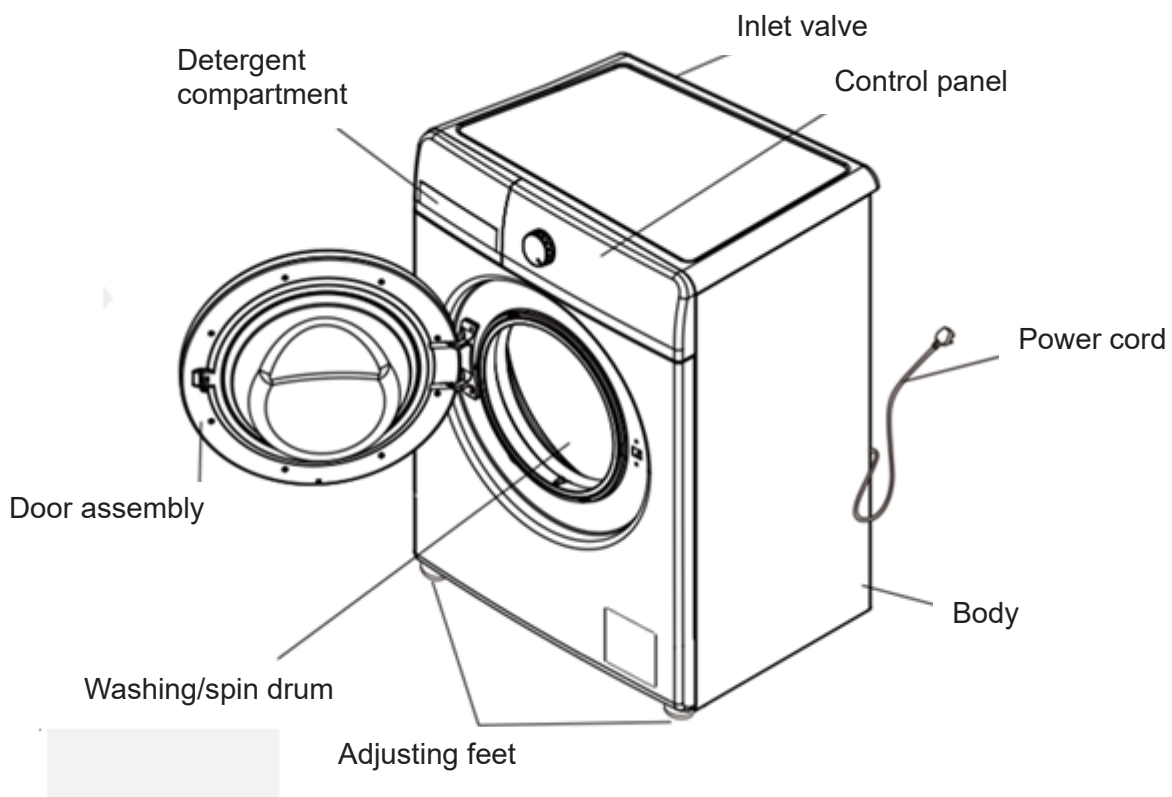

The figure above is only for reference!

Notes:

1. When washing clothes for the first time, some water may flow from the washing machine. This is what is left during the performance test at the factory. This phenomenon is normal.
2. After using, please pull out the power plug, turn off the faucet to prevent unexpected flood and fire.

INSTALLATION INSTRUCTIONS

- The environmental temperature of places to install or place the washing machine shall not be below 0 °C. Do not install or place the washing machine outdoors.
- Follow management practices and regulations to correctly place the washing machine.
- When the washing machine is installed on a floor with a carpet, do not block the ventilation orifice of the base.
- There are many insects in the countryside. Please keep the surroundings of the washing machine clean. The warranty does not cover any damage caused by cockroaches or other insects.

Shipping bolts

The shipping bolts are used to prevent internal damage of the washing machine during transport.

Disassembling the shipping bolts and the bottom panel

1. Open the package, remove the packaging base and move the washing machine to the installation place.
2. Disassemble the 4 shipping bolts, rubber pads and plastic rods (see Figure 1). If the shipping bolts are not disassembled, they may cause intense vibrations, noise and faults. The shipping bolts shall be installed every time before the washing machine is transported.
3. Use the supplied plastic plugs to cover the four holes. (see Figure 2).

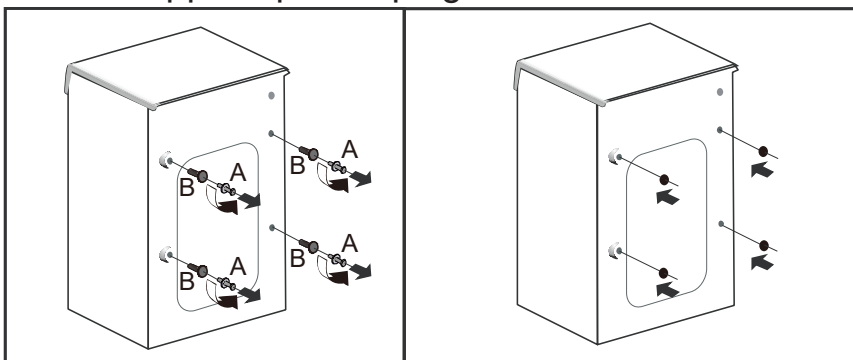

Figure 1

Figure 2

Requirements for installation place

Horizontal adjustment:

- The tilt angle shall not exceed 1 degree. Power outlet:
- Do not connect to a number of power plugs.

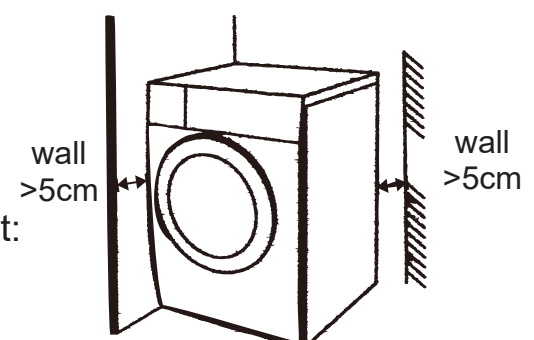

Installation place:

- Allow sufficient safety distance between the washing machine and the wall (distance between the back/left/right of the washing machine and a wall >5cm).
- Install the washing machine at a hard and flat floor with a drain. Do not install it on soft carpeted or wooden floors.
- Do not put clothes to be washed or other objects at the worktop of the washing machine because they will affect the running of programs.

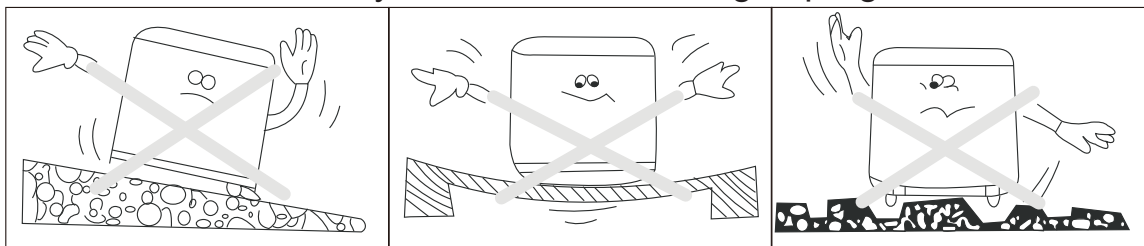

NOTES

Connecting the power supply

1. Do not use a power strip or power strip bar.
 2. If the power cord is damaged, please contact professional persons to repair it to avoid injuries.
 3. After using, please unplug the power plug and turn off the faucet.
 4. Connect the power cord of the washing machine to a grounded power outlet and follow the wiring rules.
 5. The washing machine shall be installed at a place where it can connect to the power outlet easily.
- The washing machine shall be repaired by professional persons. Non-professional persons may damage the washing machine seriously or cause serious faults during repair, please contact the local repair center.
 - Do not place the washing machine at a place whose surrounding temperature may be below 0 °C because water pipes will be frozen and broken and the program controller will be damaged at the temperature below 0 °C.
 - If the washing machine is handled in winter at the temperature below 0 °C, please place it at room temperature several hours before using.

Connecting the power supply

- The washing machine must have a grounding device. The grounding device can reduce the danger of electric shocks in case of a failure. This device has a grounding line (a conductor with a grounding plug). The grounding plug must be inserted into an appropriate power outlet.
- If the washing machine smokes or emits a peculiar smell, please cut off the power supply and contact professional persons.

To ensure quality, the washing machine is filled with water for testing at the factory, water may remain in the interior of the drum, the door seal and the door glass, and this is a normal condition.

Connecting the water supply hose

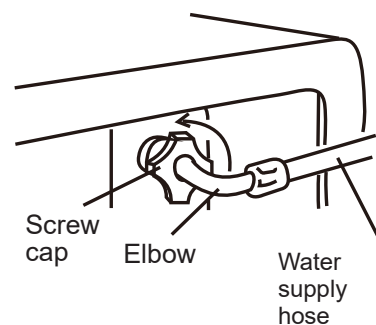
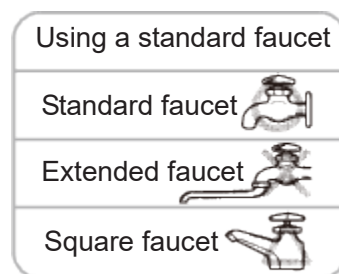

1. The water supply pressure shall be from 50kPa to 850kPa.
 2. During connection of the water supply hose and the inlet valve, do not screw them tightly to avoid slipping.
- There are 2 seal rings in connectors at both ends of the water supply hose to prevent water from leaking.
 - Turn on the faucet to check the connectors for any water leakage.
 - Check the water supply hose regularly and replace it if necessary.
 - Make sure that the water supply hose is not warped or damaged.



⚠ NOTES

Use the new hose assembly that comes with the washing machine. The old hose assembly cannot be reused.

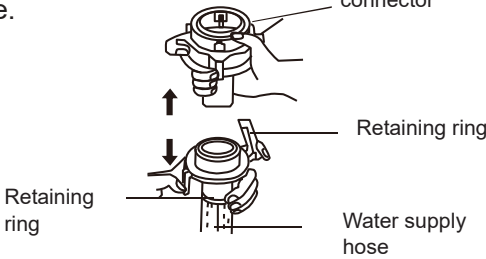
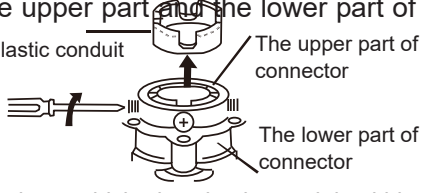
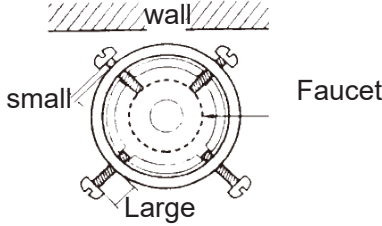
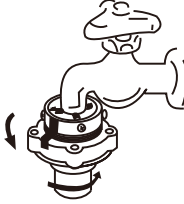
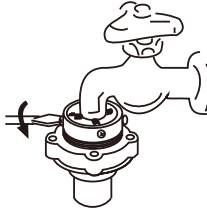
Connection of water supply hose to faucet

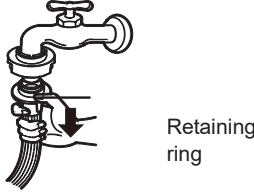
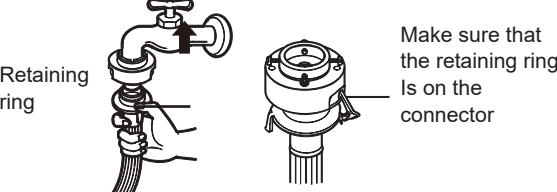
<p>1. Hold the connector with one hand, press the retaining ring with the other hand and pull it down to separate the connector from the water supply hose.</p> 	<p>2. Loosen the four mounting screws on the upper part of the connector, and rotate the lower part of the connector to leave a distance enough (equal to the height of 3 threads) for installing screws between the upper part and the lower part of the connector.</p>  <p>! If the tap pipe is too thick, the plastic conduit within can be removed</p>
<p>3. Adjust the four screws of the connector evenly so that two screws near the wall are fully in contact with the exterior of the faucet first.</p>  <p>! Screw near the wall can be screwed several threads in advance.</p>	<p>4. Hold the upper part of the connector against the mouth of the faucet so that the seal ring in the connector is fully in contact with the faucet (please do not take out the seal ring).</p>  <p>! Please choose standard faucet, faucet mouth must be smooth. If it is uneven, file it.</p>
<p>5. Rotate two screws (see figure) opposite to the wall so that they are in contact with the faucet, and screw them with a screwdriver tightly.</p> 	<p>6. Rotate the lower part of the connector to screw it tightly (or else, water may leak from the connection). After rotation, the clearance between the lower part and the upper part of the connector shall be lower than 3mm.</p> 
<p>7. To remove the water supply hose, please press the retaining ring of the water supply hose.</p> 	<p>8. To install the water supply hose, please turn the retaining ring of the water supply hose back to release it.</p>  <p>Make sure that the retaining ring is on the connector</p>
<p>9. Check whether or not the lower part of the connector and the water supply hose are connected firmly.</p> <ul style="list-style-type: none"> ● Screw the connector of the water supply hose and the inlet valve tightly. Slowly turn on the faucet to check for water leakage. ● If water leaks from the connection, please turn off the faucet and assemble them again. (Water may leak from the connection if the upper part of the connector is not assembled correctly or the upper part and the lower part of the connector are not screwed on tightly.) ● After using for a long time, the connection may be loose. Then, please assemble parts again by following steps 1-9. (If it is necessary to assemble the connector of the water supply hose after a move, please follow steps 1-9 too.) 	

NOTES:

If a special faucet shown in the figure below is used, please take the following steps to assemble the parts:

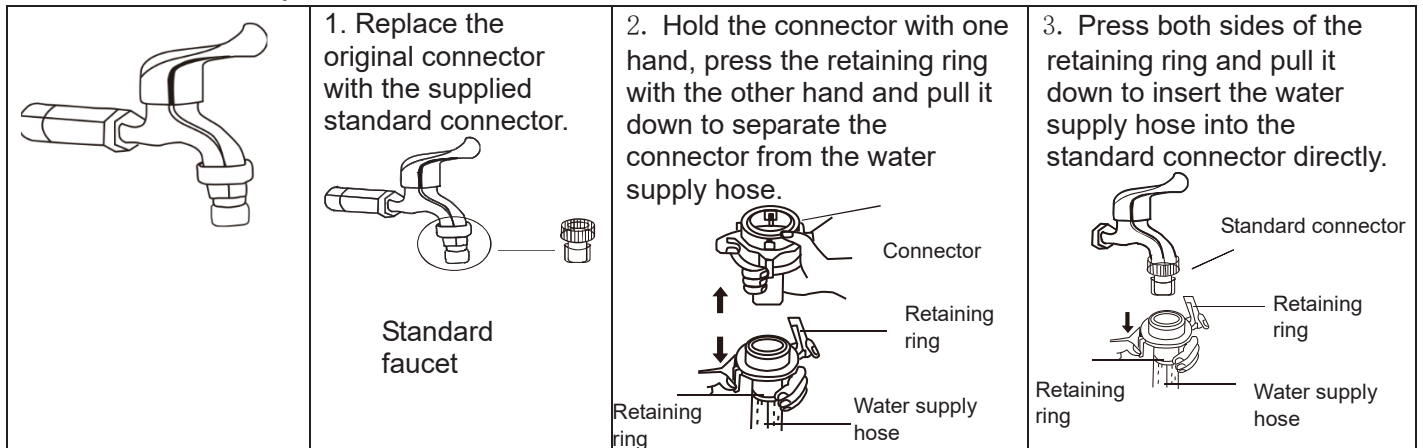

If the faucet with threaded port shown in the figure below is used, please follow the steps below for installation:

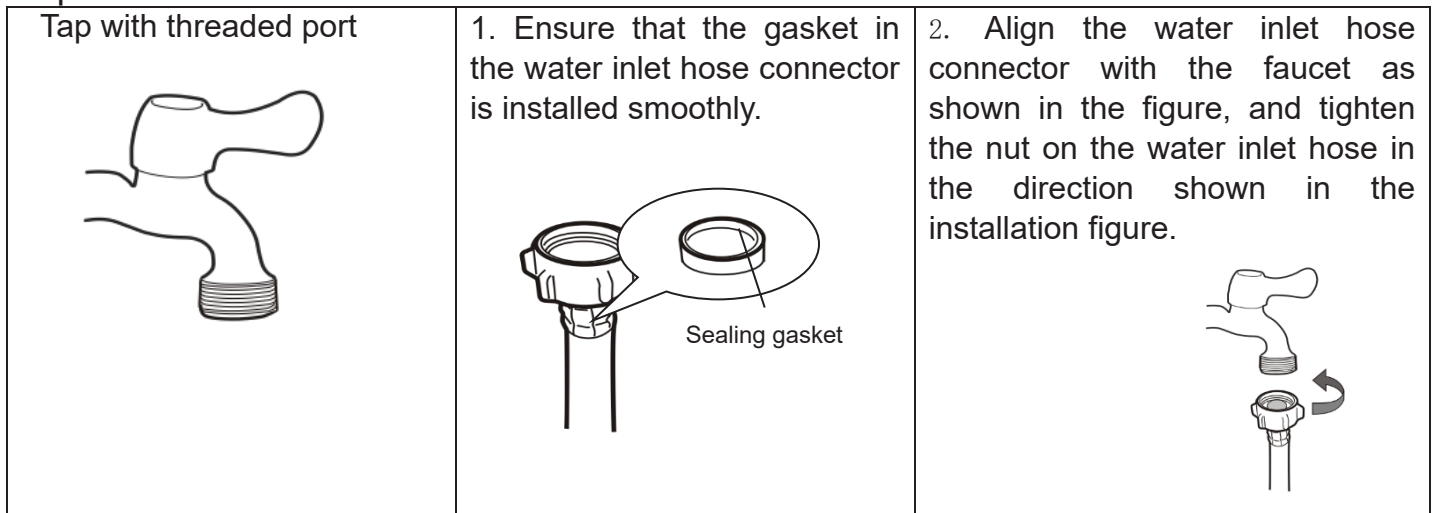

- The washing machine is designed for home use only. Do not use it on ships, travel trucks or airplanes.
- If the washing machine will be not used for a long time (such as vacations), please turn off the faucet.
- When the washing machine is placed, please unplug the power plug, cancel the lock function to prevent children being trapped inside the washing machine through misuse.
- Packaging materials (such as films and foams) can be dangerous to children, and may cause suffocation! Notes: Keep all packaging material out of the reach of children.

Installing the drain hose

- To ensure normal operations of the washing machine, the inner diameter or width

of the end of the drain hose to be inserted into the sewer shall be no less than 4cm.

- The height of the outlet of the drain hose shall be within a certain range. For specific data, please refer to the figure below.

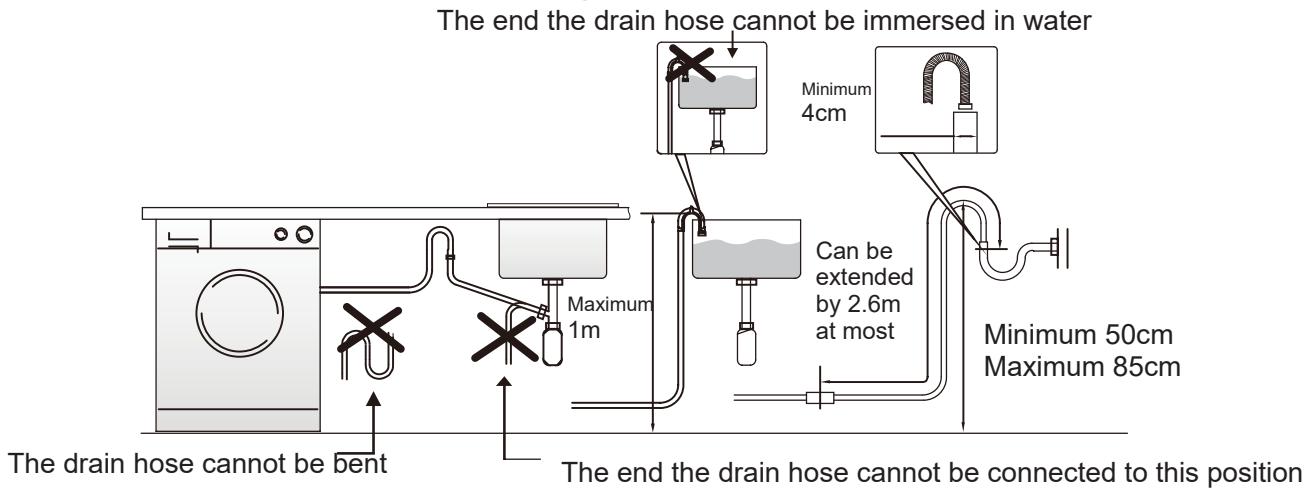

Horizontal adjustment

- Adjust the level of the washing machine to avoid additional noise and vibrations. Install the washing machine on a hard and horizontal floor (the corner of a room is preferred).
- If the floor is not flat, please adjust the adjustable feet. (Do not insert objects such as wood chips under the adjustable feet). Make sure that the four adjustable feet are in contact with the floor firmly and check that the washing machine is horizontal. (Using a spirit level is allowed).
- Adjust the adjustable feet so that the washing machine is flat and stable on the floor. After position adjustment, screw the locknuts tightly to keep the washing machine stable.

Do not place the washing machine on a table on the floor to prevent it from falling accidentally.

- When pressing any position on the diagonals of the worktop of the washing machine, the washing machine cannot shake. (Check on both diagonals. If the washing machine still shakes, please adjust the adjustable feet again.)

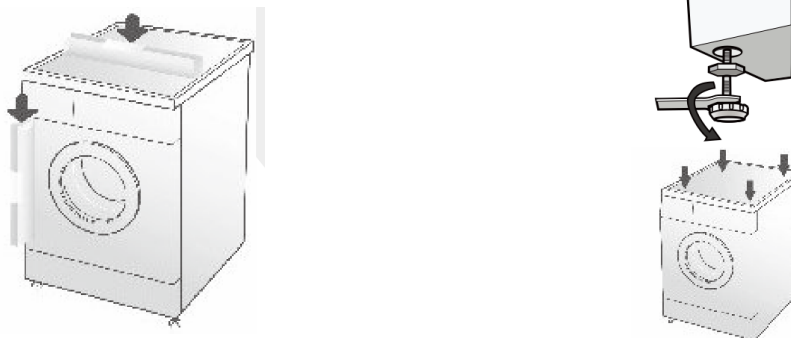

DOOR LOCKING AND UNLOCKING METHODS

Door locking

After startup, the door will be locked automatically and cannot be opened.

Door unlocking

- Press the “Start/Stop” button when the door lock is locked. After the washing/spin drum stops rotating, wait for 2 minutes until the door is unlocked automatically.
- Foams may rise from the drum during washing. Please catch them with a towel.
- During washing, the door cannot be opened at high temperature.
- During washing, the door cannot be opened with high water level.

USAGE OF DETERGENT COMPARTMENT

Multi-squared detergent compartment

Liquid detergent—bleacher

- Please use synthetic low-foam liquid detergents.
- If concentrated liquid detergents are used, please dilute them with water (2:1) and pour them into the detergent compartment.

Prewash detergent

- If the clothes are very dirty, please add appropriate detergents after selecting the pre-wash function. (The quantity of detergents varies with models)

Fabric Softener

- Add softeners before washing. The washing machine will automatically inject softeners into the drum during the final rinse.
- If concentrated softeners are used, please dilute them with water appropriately and evenly and pour them into the detergent compartment.

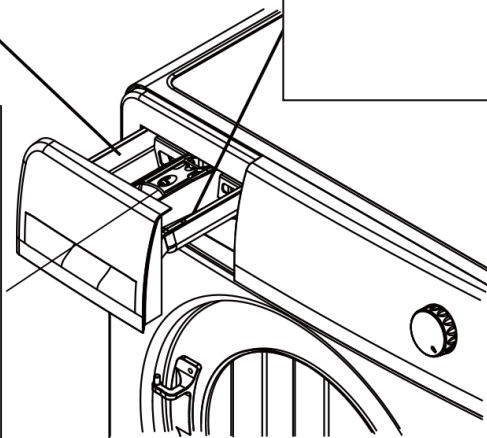

- Use detergents made specially for drum washing machines.
- Do not use too much detergent, or too much foams may affect the rinse effect or cause functional faults.
- Please follow the instructions of the manufacturer to use detergents by the kinds and colors of clothes, water temperature, degree of staining, etc.
- Using appropriate detergents has good washing effect and is beneficial for environmental protection.

SAFETY PRECAUTIONS BEFORE WASHING







1. Care label

- Read the care labels of clothes. The kind, materials and washing method of a cloth are printed on a care label.

2. Wash by kinds of clothes

- To obtain the best washing effect, only wash one kind of clothes in a washing period. Water temperature, spin speed and programs vary with clothes. Dark clothes shall be washed separately from light and white clothes. Dyed clothes and cotton velvet clothes shall be washed separately, or the white clothes may be stained. If possible, do not wash very dirty clothes with moderately dirty clothes.

<ul style="list-style-type: none"> ● Degree of stains (Severe, moderate, minor) ● Color (White, light, dark) ● Cotton velvet (clothes whose cotton velvets are easy to drop out and clothes easy to adhere to cotton velvets) 	<ul style="list-style-type: none"> ● Wash by kinds of clothes and degree of staining ● White clothes shall be washed separately from colored clothes. ● Clothes whose cotton velvets are easy to drop out and clothes easy to adhere to cotton velvets
--	---

 <p>Check whether or not the clothes are machine-washable</p>	 <p>For clothes whose buttons or accessories are easy to be damaged during washing, please wash inside out</p>	 <p>Remove dust and silt from clothes before washing</p>
 <p>Take out objects such as keys, hairpins, pins and coins from pockets</p>	 <p>Put delicates into a laundry bag before washing</p>	 <p>Wash clothes with oil stains or clothes that are easy to fade separately</p>

FUNCTIONAL DESCRIPTION CONTROL PANEL

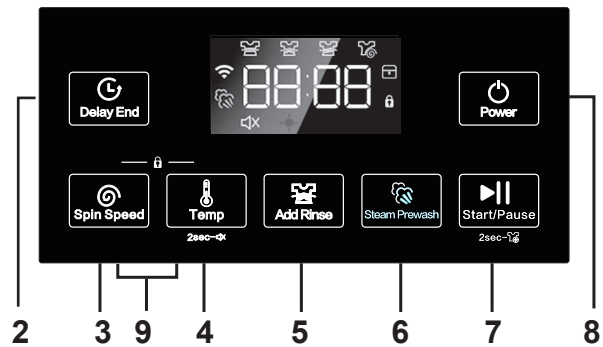
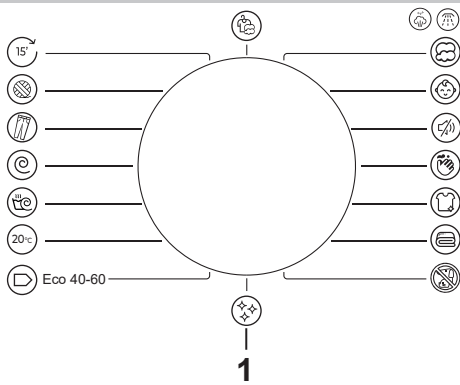

1. PROGRAM KNOB

Select the appropriate procedure according to the type of washing clothes and the degree of stains.

2. “DELAY END” BUTTON

- This button for preset the program.
- Enter the preset function, the display screen will display the total time of the presetting program, and the washing program will be started automatically after the preset time. Each time you press it, 1 hour will be added to the time of the washing procedure, up to 24 hours.
- The preset time should be selected after selecting the required program and before pressing the Start/Pause button.

3. “SPIN SPEED” BUTTON

- Select the spin speed according to the amount of clothes and the type of clothes.
- The setting range of spin speed is different due to different programs.

4. “TEMP” BUTTON

- Select the water temperature by the kinds of clothes and degree of staining.
- The range of water temperature varies with programs. In some programs, water temperature cannot be selected.
- Press and hold down this button for more than 2 seconds to turn the mute function on/off. After setting the mute function, the whole machine beeps without making a sound.

5. “ADD RINSE” BUTTON

Increase the number of rinses according to actual demand.

6. “STEAM PREWASH” BUTTON

- Before starting the program, press the "STEAM PREWASH" button to select the steam prewash function (the steam prewash function only can be selected in a few programs).

7. “START/PAUSE” BUTTON

- Press this button to start or stop the washing procedure.
- During operations, press this button to stop the program temporarily, and press it again to restore the selected program.
- Press and hold this button for 2 seconds to open the door temporarily for adding clothes during

operation. As the door lock of the machine has a protection function, the door can only be opened if the conditions for unlocking the door lock are met.

















8. “POWER” BUTTON

- Press this button to turn on or turn off the power.
- Press this button to turn on the power supply. If it is not operated, it will turn off automatically after 2 minutes.

9. “CHILD LOCK” BUTTON

- Press the combination buttons on the control panel at the same time to turn on or turn off the child lock function.
- In order to prevent children from mis-operation, the buttons can be used to set the child lock function.
- After setting the child lock function, other buttons except the power button do not work.

DESCRIPTION OF WASHING PROGRAMS

Program	Water temperature (°C)	Rinse (times)	Maximum load	Kind of clothes
 Mixed	40/ambient temp/20	2	≤4kg	Cotton/Synthetic fabrics
 Cotton	40/60/80/ambient temp/20	2	Rated	Common cotton fabric
 Kid Wear	60/80/ambient temp/20/40	3	≤4kg	Cotton fabrics needing simple cleaning and odor removal
 Night	40/60/ambient temp/20	2	≤4kg	Cotton + linen/ Synthetic fabrics
 Gentle	40/ambient temp/20	2	≤3kg	Cotton/Synthetic fabrics
 Shirts	20/40/ambient temp	2	≤4kg	Cotton/Synthetic fabrics
 Bulky	40/60/80/ambient temp/20	2	≤3kg	Cotton/Synthetic fabrics
 High Temp	80	2	≤4kg	Cotton fabrics needing and mite killing and sterilization
 Drum Clean	80	2	/	Cleaning and sterilization of washing machine
 Eco 40-60	/	2	Rated	Dirty Cotton/Synthetic fabrics
 20°C	20	2	≤3kg	lightly soiled cotton laundry
 Rinse+Spin	/	1	Rated	Cotton/Synthetic fabrics
 Spin	/	/	Rated	Cotton/Synthetic fabrics
 Jeans	ambient temp	2	≤3kg	Jeans clothes
 Wool	ambient temp/20/40	2	≤3kg	Machine-washable wool fabrics
 Quick15'	ambient temp/20/40	1	≤2kg	Not very dirty clothes/frequently used towels

Notes:

1. The first parameter of water temperature is the default parameter at startup. You can select other parameters manually.
2. The running time of the program will change when the water pressure, drainage conditions, clothing material, clothing weight and water temperature change, so the running time is different each time. This is normal.
3. When the washing machine starts up after a power failure, it runs from the time node before the power failure.

DESCRIPTION OF FUNCTIONAL PROGRAMS

Washing usage of clothes

1. Prepare for washing
 - Open the door, put clothes in the drum, and close the door.
 - Withdraw the detergent compartment, add detergent and fabric softener, and close the detergent compartment.
 - Connect the water supply hose, and make sure that the faucet is turned on.
2. Press the "Power" button to power on.
3. Select a program with the program selection knob as needed.
4. Press the "Start/Pause" button to start washing.
5. After washing is ended:
 - The display shows "END" and the washing machine gives a buzzing sound. It will turn off automatically after 1 minute.
 - Open the door to take out the clothes.
 - Unplug the power plug and turn off the faucet.

Usage of self-program

1. Prepare for washing
 - Open the door, put clothes in the drum, and close the door.
 - Withdraw the detergent compartment, add detergent and fabric softener, and close the detergent compartment.
 - Connect the water supply hose, and make sure that the faucet is turned on.
2. Press the "Power" button to power on.
3. Turn the program knob to select the desired program.
4. Press the "Temp" button to set the water temperature.
5. Press the "Spin Speed" button or "Temp" + "Spin Speed" button to set the spin speed and preset time.
6. Press the "Start/Pause" button to start washing.
7. After operation is ended
 - The display shows "END" and the washing machine gives a buzzing sound. It will turn off automatically after 1 minute.
 - Open the door to take out the clothes.
 - Unplug the power plug and turn off the faucet.

MAINTENANCE AND SERVICING

- After using for a long time, please service the washing machine immediately. Good servicing practices may extend the service life of the washing machine.
- Before servicing, please unplug the power plug to avoid dangers from happening.

Housing

Please wipe the body with a soft and clean cloth every time after the washing machine is used. When there are serious stains, please wipe the body with a cloth dipped in appropriate detergents or soapy water.

- Do not spray water on the body directly.
- Do not wipe the body with chemicals such as putty-powder, diluting agents, gasoline and alcohol.

Door seal

Please wipe stains and foreign matters such as thread chips away with a towel every time after using. If there are foreign matters such as pins in the groove of the door seal, please take them out.

Cleaning the detergent compartment

- To prevent detergents becoming moldy on the wall of the detergent compartment, please clean the detergent compartment regularly.
- Press the specified position and pull out the detergent compartment, wash it with water and put it back

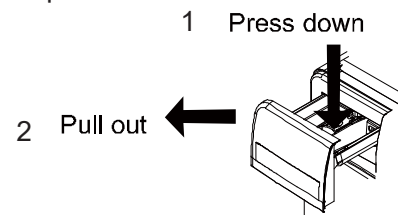

If the washing machine is frozen

1. Wrap the faucet and the universal coupling with a hot towel.
2. Remove the water supply hose and immerse it in hot water at the temperature of approximately 50°C.
3. Pour 2~3 liters of hot water at the temperature of approximately 50°C into the drum.
4. Connect the water supply hose again, turn on the faucet, start up the washing machine, and check whether or not the water supply and drainage are normal.

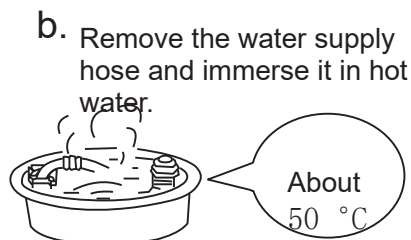
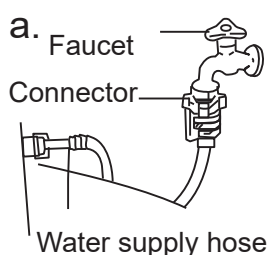

c. Pour 2~3 liters of hot water into the drum.

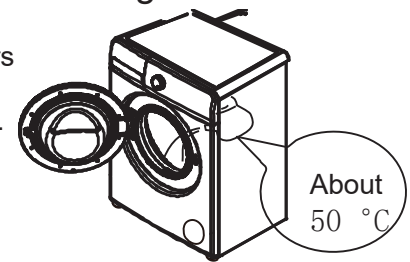

Self-cleaning of drum (once a month is recommended)

After using for a long time, there may be stains in the washing drum. The self-cleaning program can be used to clean the exterior and the interior of the drum.

Notes: During self-cleaning, do not add clothes or detergents.

Cleaning the universal coupling (once every six months is recommended)

1. Remove the water supply hose from the universal coupling.
2. Screw off the fastener by following the arrow.

- Rinse the interior of the fastener with water.
- Install the clean fastener and the water supply hose.

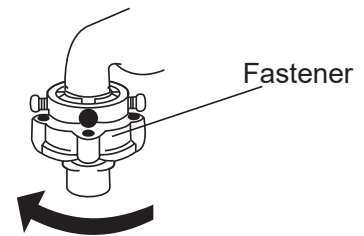

Cleaning the inlet valve (once every six months is recommended)

- Remove the water supply hose from the washing machine.
- Take out the filter screen from the inlet valve.
- Clean the filter screen thoroughly with a toothbrush or similar tools. Install it to the inlet valve.
- Connect the water supply hose again.

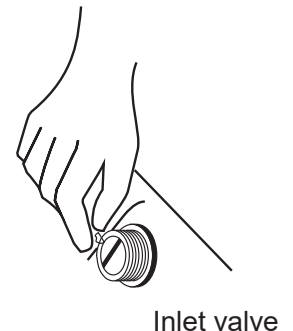

Cleaning the filter of the drainage pump (once a month is recommended)

- After drainage, disconnect the power plug, press the clip above the decorative cover for the drainage pump at the right corner in the front of the body, and open the filter cover. (Note: if there is hot water in the washing machine, please take the above actions only after cooling.)
- Screw off the filter anti-clockwise.
- Rinse the filter thoroughly with water.
- Insert the filter, screw it clockwise and close the decorative cover for the drainage pump.

- Notes:**
- The filter must be tightly screwed to prevent water from leaking.
 - Do not clean the filter when a program is running.

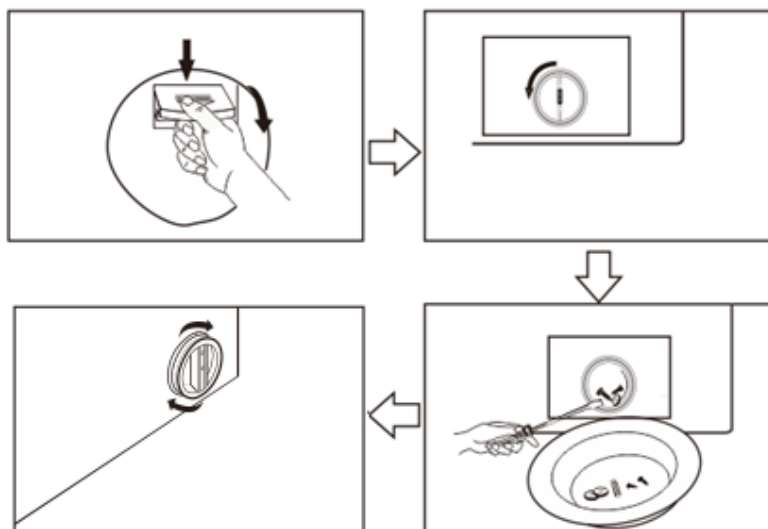

TROUBLESHOOTING GUIDELINES

Symptoms	Check points	Solutions
The washing machine cannot start	<ul style="list-style-type: none"> ● Is the "Power" button or "Start/Pause" button pressed? ● Is the plug of the power cord pulled out? ● Is there a power failure? ● Is the leakage protector broken? 	<ul style="list-style-type: none"> ● Press the "Power" button or "Start/Pause" button. ● Insert the plug of the power cord. ● Please wait. ● Turn on the leakage protector.
Abnormal spin	<ul style="list-style-type: none"> ● Are the shipping bolts disassembled? ● Is the washing machine assembled firmly? ● Are there single small clothes in the drum? ● Are the locknuts for the adjustable feet screwed tightly? 	<ul style="list-style-type: none"> ● Disassemble the shipping bolts. ● Put the washing machine on a flat and even floor. ● Add several similar clothes. ● Screw locknuts tightly.
Water inlet fault displays "E01"	<ul style="list-style-type: none"> ● Is the faucet turned off? ● Is there a water outage or is water pressure low? ● Is the water supply hose frozen? ● Is the water supply hose or the inlet valve blocked? 	<ul style="list-style-type: none"> ● Turn on the faucet. ● Please wait. ● Unfreeze the water supply hose with hot water. ● Take the filter screens out from the water supply hose and the inlet valve and thoroughly clean them.
Drainage fault displays "E03"	<ul style="list-style-type: none"> ● Is the height of the drain hose too high? ● Is the drain hose frozen? ● Is the drain hose blocked by foreign matters? ● Is the floor drain blocked by foreign matters? 	<ul style="list-style-type: none"> ● Please put the drain hose well and make sure that the height is below 1m. ● Unfreeze the drain hose with hot water. ● Take the foreign matters out and empty the drain hose. ● Remove foreign matters from the floor drain.
Door fault displays "E02"	Make sure whether or not the washing machine starts when the door is not closed tightly?	Close the door tightly.
No heating fault displays "E06"	Turn off the faucet and disconnect the power plug. Then, contact professional maintenance personnel	
Continuous water inflow fault displays "E04"	Turn off the faucet and disconnect the power plug. Then, contact professional maintenance personnel	
Too much foam	Are low-foam detergents special for drum washing machines used?	It is recommended to add the appropriate detergents.

Note: When a fault occurs, only the corresponding display is forced to flash and beep, indicating that the machine is currently in a fault state.

Notes: the following conditions do not represent faults

The door cannot be opened	<ul style="list-style-type: none"> ● A program is running.
Peculiar smell	<ul style="list-style-type: none"> ● Because rubber parts are used in the washing machine, there can be a rubber smell at the beginning.
Low water quantity during washing and rinsing	<ul style="list-style-type: none"> ● Drum washing machines wash clothes with a liter of water.
Water inflow during running of programs	<ul style="list-style-type: none"> ● If the water level decreases, the washing machine automatically replenishes water.
Drainage during washing	<ul style="list-style-type: none"> ● Are too many or high-foam detergents added?
Variation of remaining time	<ul style="list-style-type: none"> ● During spinning, if the clothes are off center, the spin time will increase appropriately to correct this phenomenon. ● If the water pressure is too low, the inflow time will increase appropriately.
Abnormal sound during spinning	<ul style="list-style-type: none"> ● Is the power cord contact with the housing? ● Are the shipping bolts disassembled? ● Are there foreign matters such as hairpins and coins in the drum?

SPECIFICATIONS TABLE

Model	AL6205AIDV
Door assembly	18
Rated washing capacity	6.0kg
Rated spinning capacity	6.0kg
Rated voltage	220-240V~ 50Hz
Rated washing power	250W
Rated spinning power	500W
Rated heating power	1800W
Maximum power	1900W
Washing/Spinning noise	62dB(A)/ 75dB(A)
Water pressure	0.05-0.85MPa
Overall dimensions(mm)	598×445×845
Applicable standards	IEC60335-2-7:2019, IEC 60335-1:2010, COR1:2010, COR2:2011, AMD1:2013, COR1:2014, AMD2:2016, COR1:2016

NAME AND CONTENT OF HAZARDOUS SUBSTANCES USED IN THIS APPLIANCE

Component names	Hazardous substances					
	Plumbum (Pb)	Hydrargyrum (Hg)	Cadmium (Cd)	Hexavalent chromium Cr (VI)	Polybrominated biphenyls (PBB)	Polybrominated Diphenyl Ethers (PBDE)
Door lock	×	○	○	○	○	○
Computer board	×	○	○	○	○	○
Power cord	○	○	○	○	○	○
Bolt and nuts	○	○	○	○	○	○
Water level sensor	○	○	○	○	○	○
Draining Valve	○	○	○	○	○	○
Motor	×	○	○	○	○	○
Belt, pulley	○	○	○	○	○	○
Door assembly	○	○	○	○	○	○
Top cover assembly	○	○	○	○	○	○
Control panel components	○	○	○	○	○	○
Housing	○	○	○	○	○	○
Inner barrel	○	○	○	○	○	○
Base	○	○	○	○	○	○
Detergent box	○	○	○	○	○	○
Inner and outer washing barrel	○	○	○	○	○	○

Notes:

1. This table is compiled according to SJ/T 11364.
2. ○: It indicates that the contents of this hazardous substance in all homogeneous materials used for this component are below the limit specified in GB/T26572.
3. X: Indicates that the content of the hazardous substance in at least one homogeneous material of the part exceeds the limitation requirements specified in GB/T26572, but is within the scope of "Application Exception List of Restricted Substances of the Catalog of Compliance Management".



The "environment-friendly use period" of this appliance is 10 years, and it is specified by this enterprise according to the design characteristics of this appliance. This "environment-friendly use period" is valid only when this appliance is used normally by following this Owner's Instructions.

AFTER-SALE SERVICE

Three-year warranty service is available from the date of purchase. The date of purchase of the invoice or after-sales service warranty card is subject to the warranty service. The problems you encounter when using our company's home automatic washing machine can be helped and resolved through the service hotline. We provide technical advice free of charge.

● Any of the following conditions is not covered by the warranty;

- 1) Components are damaged due to improper use, maintenance and storage.
 - 2) Damage caused by disassembly and assembly of products without the maintenance personnel of the company or designated special maintenance personnel.
 - 3) No purchase invoice or purchase invoice does not match the product;
 - 4) Damage caused by force majeure;
 - 5) Exceeding the warranty period;
 - 6) This product is an ordinary household washing machine. For commercial or collective washing machines, such as hotels, hair salons, laundries, factories and dormitories, the warranty period is six months. Beyond the warranty period, our company will charge for maintenance according to the relevant regulations of our company.
- ★ If you find any quality problems, please contact the service center or special maintenance service point for repair. Do not disassemble it yourself. The company will not bear any responsibility for quality problems or accidents caused by self-disassembly.

Correct disposal of this product



This marking indicates that this product should not be disposed with other household wastes throughout the EU. To prevent possible harm to the environment or human health from uncontrolled waste disposal, recycle it responsibly to promote the sustainable reuse of material resources. To return your used device, please use the return and collection system or contact the retailer where the product was purchased. They can take this product for environmental safe recycling.

Imported by B73737553
Av Altos Hornos S/N Pto
Sagunto (46520) Valencia,
España www.aspes.es
aspes@sareteknika.es
902 99 69 01 / 944 04 14 08